

Varenummer: 03446100
Beskrivelse: Fluro Heavy Duty Ledleje GE 100 GW-2RS
Hul Ø100
Note: 100

Mål

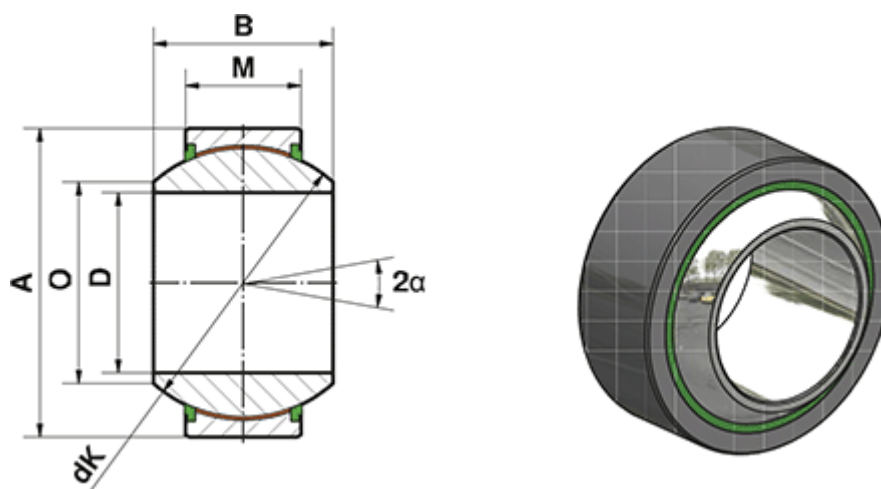

= -	Dynamisk belastning C (kN) = 1845
= -	M = 55
= -	O = 111.2
A = 160	Statisk belastning C0 (kN) = 3075
a (grader) = 14	Vægt (g) = 6000
B = 85	
D = 100	
dK = 140	